

1E3210DA90 | ZEDGE Pro

Recessed wall mounted LED fixture

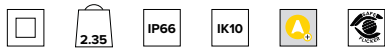

The fixture's photometric values can be found on the following pages

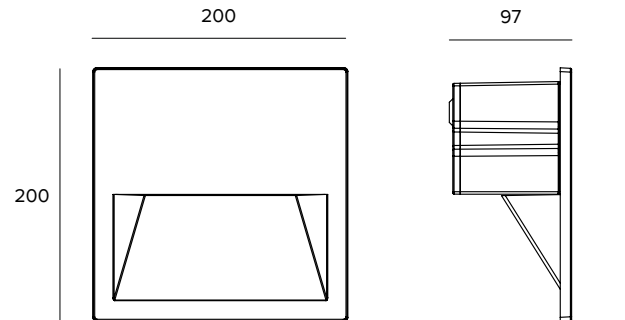

The figures on the drawing are expressed in mm.

SOURCE

2 high efficiency Ra90 LED Chip on Board.

Energy efficiency class: E

Nominal power: 14W

Nominal flux: 1672lm

Colour rendering index: 90

Rf: 92

Rg: 99

CCT nominal: 2700K

SDCM: 2

Lifetime (L80/B10): >50000h tq +25°C

ILLUMINOTECHNICAL CHARACTERISTICS

The internal optical system is composed of 2 metallised polycarbonate reflectors coupled to two high reflectance anodised aluminium reflectors and holographic filters. Louver screen in silk-screen printed extra-clear glass. ADJUSTABLE version - that allows to change from one beam to the other in a uniform way by adjusting the 2 optical systems.

Optic: FLOOR WASHER

Optical efficiency: See photometries

Fixture flux: See photometries

Luminous efficacy: See photometries

Photobiological safety: Compliant with RG1 low risk group

MECHANICAL CHARACTERISTICS

The body of the fixture and the external frame are made of powder coated die-cast anodised aluminium.

Colour and finish: Ferrite

Weight: 2.35Kg

Version: ADJUSTABLE

Degree of protection: IP66

Mechanical Resistance: IK10

ELECTRICAL CHARACTERISTICS

Complete with a dimmable DALI power supply. Pre-cabled with a 1m H07RN-F (4x1mm²) cable. Luminaire compliant with EN 60598-2-22 for power supply from a centralised emergency system CPSS (Central Power Supply System), not incorporated in the luminaire - high risk areas excluded. The default power and flux are 100% in AC and 100% in DC.

Fixture Power: 16W

Power supply: 220-240Vac 50/60Hz

Insulation Class: CLASS 2

Type of driver / Control: DALI - PUSH

Driver included: YES

Class F: YES

SAFE FLICKER: PstLM=<1 and SVM=<0.4 (IEC TR 61547-1 and IEC TR 63158), to ensure a more comfortable and safe light

Ambient temperature: -25°C / +35°C

INSTALLATION

To be completed with a special nylon outer casing fitted for parallel connection.

NOTES

Designed in collaboration with Gensler. Casambi control system available using a dedicated accessory. Uses the "Waterblock Smart" technical solution that involves resin coating the connection cables, limiting the risk of humidity reaching the driver or the fixture. It is possible to subject the product to Cataphoresis treatment on request. 110-277Vac version available on request. Commissioning of the control system via free APP; the intervention of a specialist technician can be quoted on request.

WARRANTY

5 years.

WARNING

Luminaire designed for disposal/recycling at end-of-life. Replaceable (LED only) light source by a professional. Replaceable control gear by a professional.

Due to the technological evolution of the electronic components, the data provided may be updated, and as such, confirmation must be requested during the order process.

Luminous flux and power supply have +/-10% tolerances with respect to the indicated value. tq +25°C (CIE 121).

We reserve the right to make technical changes.

Targetti Sankey S.r.l.
Via Pratese, 164
50145 Firenze - Italy
Tel: +39 055 37911
targetti.com
targetti@targetti.com

CCIAA Firenze
Share Capital:
€ 500.000,00
VAT N. (IT):
01537660480
R.E.A: FI-275656

TARGETTI

1E3210DA90 | ZEDGE Pro
Recessed wall mounted LED fixture

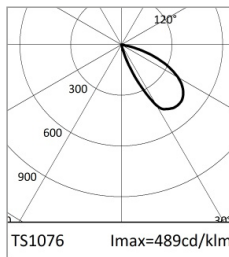

	2700K	H(m)	D1(m)	D2(m)	E _{max} (lx)		
	Ra90		44°	53°			
Fixture Power	16W	1	2.06	1.38	455		
Source Flux	1672lm	2	4.11	2.77	114		
Fixture Flux	573lm	3	6.17	4.15	51		
Efficacy	37lm/W	4	8.23	5.53	28		
TS1076	I _{max} =489cd/klm	I _{max}	818cd	5	10.29	6.92	18

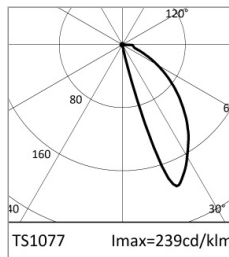

	2700K	H(m)	D1(m)	D2(m)	E _{max} (lx)		
	Ra90		32°	105°			
Fixture Power	16W	1	0.82	2.79	270		
Source Flux	1672lm	2	1.63	5.58	68		
Fixture Flux	384lm	3	2.45	8.38	30		
Efficacy	25lm/W	4	3.27	11.17	17		
TS1077	I _{max} =239cd/klm	I _{max}	400cd	5	4.09	13.96	11

DEEP WW

Fixture flux 573lm
 Luminous efficacy 37lm/W
 Optical efficiency 34%

WIDE WW

Fixture flux 384lm
 Luminous efficacy 25lm/W
 Optical efficiency 23%

Due to the technological evolution of the electronic components, the data provided may be updated, and as such, confirmation must be requested during the order process.
 Luminous flux and power supply have +/-10% tolerances with respect to the indicated value. tq +25°C (CIE 121).

Targetti Sankey S.r.l.
 Via Pratese, 164
 50145 Firenze - Italy
 Tel: +39 055 37911
 targetti.com
 targetti@targetti.com

CCIAA Firenze
 Share Capital:
 € 500.000,00
 VAT N. (IT):
 01537660480
 R.E.A.: FI-275656

We reserve the right to make technical changes.



1E3210DA90 | ZEDGE Pro

Recessed wall mounted LED fixture

Related codes

Insertion Box

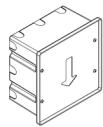

Code

1E3219

Nylon outer casing fitted for parallel connection with feed through-wiring.
AxBxH=207x207x14.5mm.
For flush or overlay installation.

Carter



Colour

Code

**1E3440**

Plate accessory for wall mounted installation.
Powder coated anodised aluminium.
AxBxH=201x201x107mm.

Bollard

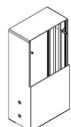

Kg	H mm	Colour	Code
3.5	400		1E3437
5.8	800		1E3438
7	1000		1E3439

Powder coated anodised aluminium bollard.

Mounting System



Code

1E3450

Fixing rods for installation in concrete.
AISI 316 stainless steel.
H=147mm.
0.36Kg.
For Zedge Pro Bollard installation with pole 1E3437, 1E3438, 1E3439.

Accessories

Connector



Code

1E2769

Linear connection box IP66/IP68.
5 poles max. wire section 1.5mm².
Cable diameter range from 7 to 12mm.



Code

1E2494

Multiple connection box IP68.
1 IN - 3 OUT 4 poles max. wire section 2.5mm².
Cable diameter range from 6 to 12mm.

Tool



Code

1E3305

Tightening wrench for the connector kit.

Due to the technological evolution of the electronic components, the data provided may be updated, and as such, confirmation must be requested during the order process.
Luminous flux and power supply have +/-10% tolerances with respect to the indicated value. tq +25°C (CIE 121).

We reserve the right to make technical changes.

Targetti Sankey S.r.l.
Via Pratese, 164
50145 Firenze - Italy
Tel: +39 055 37911
targetti.com
targetti@targetti.com

CCIAA Firenze
Share Capital:
€ 500.000,00
VAT N. (IT):
01537660480
R.E.A.: FI-275656

TARGETTI

1E3210DA90 | ZEDGE Pro

Recessed wall mounted LED fixture

Control systems



Code

1E3048

IP67 wireless control unit with DALI interface.

It generates a local DALI2 bus, enabling a direct connection to a DALI interface LED driver.

The module can only be used in a closed system and cannot be connected to an existing DALI network.

The module is wireless controlled using a Casambi app for smartphones and tablets using Bluetooth 5.0 technology.

The devices automatically create an adaptive, robust, and reliable wireless mesh network, allowing for the easy and efficient management of a high number of fixtures.

The control unit is preset to the DALI 1CH profile, meaning the device can control a single DALI driver with broadcast commands.

In addition to the DALI broadcast, other operating modes are available, such as:

- Button (normally open)
- Control unit 0/1-10V
- Control unit DALI Tunable White DT8
- Presence sensor



Code

1E4369

IP67 Extender for wireless control of LED driver with dimming DALI interface based on Casambi technology.

It has a DALI2 output with the capacity to control up to 40 lighting fixtures.

With the addition of a further external BUS DALI power supply it is possible to control up to 64 fixtures.

IP67 Extender is preset to the DALI broadcast profile, meaning all the luminaires connected to it are dimmable at the same level.

In addition to the DALI broadcast other operating modes are available, such as:

- EXTENDER DALI 8CH
- EXTENDER DALI Tunable White
- EXTENDER DALI 4CH
- EXTENDER DALI DT8 Tunable White

Surge protector



Code

A013B

Surge protector compatible with CLASS II lighting fixtures and electronic drivers.

Operating voltage 220-240Vac.

SPD type 2+3.

Max surge protection 10kV.

CLASS II

IP67

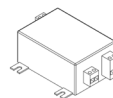

Code

A013D

Surge protector compatible with CLASS II lighting fixtures.

DALI, DMX, 0-10V datalines compliance.

Operating voltage 230-277Vac.

SPD type 2+3.

Max surge protection 10kV.

CLASS II

IP65

Due to the technological evolution of the electronic components, the data provided may be updated, and as such, confirmation must be requested during the order process.

Luminous flux and power supply have +/-10% tolerances with respect to the indicated value. tq +25°C (CIE 121).

We reserve the right to make technical changes.

Targetti Sankey S.r.l.
Via Pratese, 164
50145 Firenze - Italy
Tel: +39 055 37911
targetti.com
targetti@targetti.com

CCIAA Firenze
Share Capital:
€ 500.000,00
VAT N. (IT):
01537660480
R.E.A: FI-275656

TARGETTI